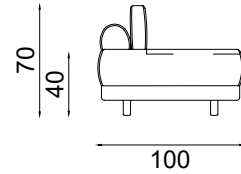
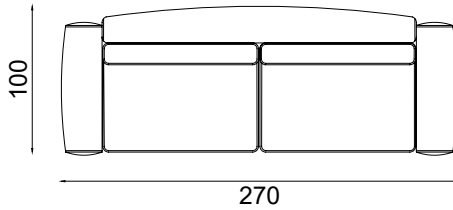
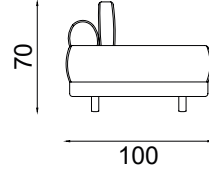
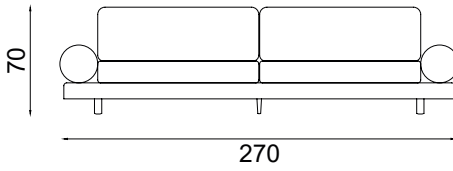
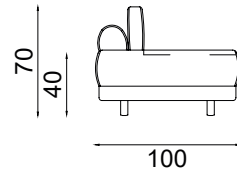
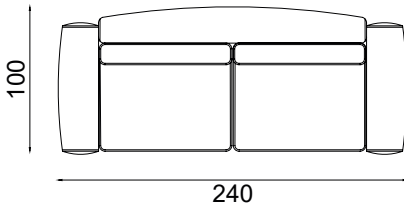
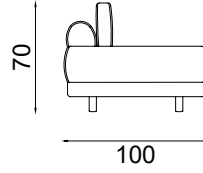
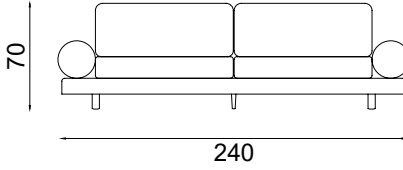
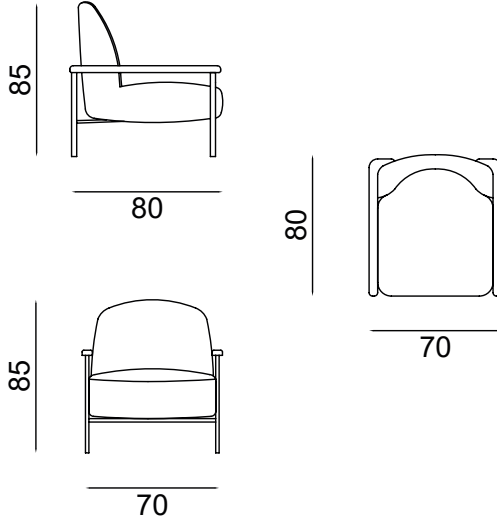

**4 SEATER /
4'LÜ KOLTUK**

Widht / Genislik	Height / Yükseklik	Depth / Derinlik	m ³
270 cm	70 cm	100 cm	1.9

**3 SEATER /
3'LÜ KOLTUK**

Widht / Genislik	Height / Yükseklik	Depth / Derinlik	m ³
240 cm	70 cm	100 cm	1.7

GIRO BERGERE /
GIRO BERJER

Widht / Genislik	Height / Yükseklik	Depth / Derinlik	m ³
70 cm	85 cm	80 cm	0.48

FABRIC OPTIONS / KUMAS OPSİYONLARI

Category 1 / Kategori 1

COLMAR PLAIN



4100 01



4100 02



4100 04



4100 06



1100 08



5375 01



5376 02



5376 03

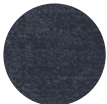

5376 05



5376 06



5376 07

Category 1 / Kategori 1

MOTTA NEW



4728 01

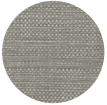

4728 03



4866 04

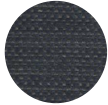

4866 05

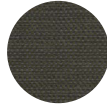

4866 06



5878 03



4675 02



4728 06

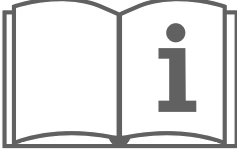

COVERS

Fabric and leather colors can vary in shade from one batch to the next and, therefore, we cannot guarantee that the color will exactly match the set of fabric samples or pieces manufactured at a later date. Please understand, therefore, that colors on fabric samples or other media are given as a rough guide only. By confirming the order, the customer accepts said tolerances.

Kumaş ve deri renkleri bir partiden diğerine gölgede değişebilir ve bu nedenle rengin setle tam olarak eşleşeceğini garanti edemeyiz. kumaş numuneleri veya daha sonraki bir tarihte üretilmiş parçalar. Bu nedenle, kumaş numunelerindeki veya diğer ortamlardaki renklerin kaba olarak verildiğini lütfen anlayın. sadece rehber. Müşteri siparişi onaylayarak söz konusu toleransları kabul etmiş olur.

MEASUREMENTS

Given the technical properties of the sofa/ottoman and cushions, overall measurements given on the price list may have a tolerance of +/- 2 cm.

Kanepeler/dizgi ve minderlerin teknik özellikleri göz önüne alındığında, fiyat listesinde verilen genel ölçüler +/- 2 cm toleransa sahip olabilir.

RH AND LH ARMRESTS

In corner configurations, note that the position of the armrests (RH or LH) is as viewed from in front of the sofa.

Köşe Konfigurasyonlarında, kolçakların konumunun (sağ veya sol) kanepenin önünden görüldüğü gibi olduğuna dikkat edin.